

## Features

### Printed circuit mount - 3 mm contact gap 50 A Power relay for photovoltaic inverters

- 2 and 3 pole versions (NO, double break contacts)
- Contact gap  $\geq 3$  mm (according to VDE 0126-1-1, EN 62109-1, EN 62109-2)
- DC coils, with only 170 mW holding power
- Reinforced insulation between coil and contacts
- 1.5 mm gap between PCB and relay base
- Suitable for use at ambient temperatures up to 85 °C (with energy-saving coil energization) or 70 °C (with standard coil energization)
- Meets the EN 60335-1 requirements of resistance to heat and fire (GWIT 775 °C and GWFI 850 °C)

### NEW 67.22-4300



- 2 NO
- Contact gap  $\geq 3$  mm
- PCB mount

### NEW 67.23-4300



- 3 NO
- Contact gap  $\geq 3$  mm
- PCB mount

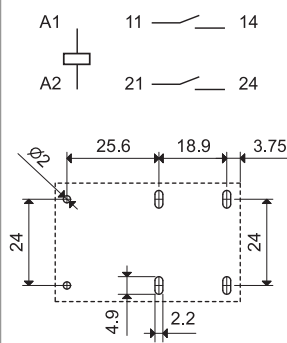

Copper side view

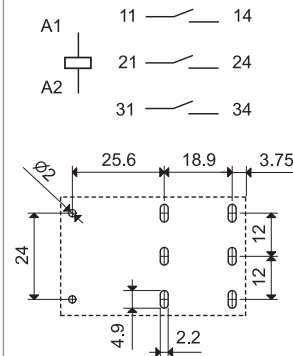

Copper side view

For outline drawing see page 6

### Contact specification

Contact configuration	2 NO (DPST-NO)	3 NO (3PST-NO)
Contact gap mm	$\geq 3$	$\geq 3$
Rated current/Maximum peak current (for 5 ms) A	50/150	50/150
Rated voltage/Maximum switching voltage V AC	400/690	400/690
Rated load AC1/AC7a (per pole) VA	20,000	20,000
Rated load AC15 (per pole @ 230 V AC) VA	2,300	2,300
Single-phase motor rating (230 V AC) kW	2	2
Three-phase motor rating (480 V AC) kW	—	7
Breaking capacity DC1: 24/110/220 V A	50/4/1	50/4/1
Minimum switching load mW (V/mA)	1,000 (10/10)	1,000 (10/10)
Standard contact material	AgSnO <sub>2</sub>	AgSnO <sub>2</sub>

### Coil specification

Nominal voltage (U <sub>N</sub> ) V DC	5 - 6 - 8 - 12 - 24 - 48 - 60 - 110	
Rated power W	1.7	1.7
Operating range (-40...+70°C) DC	(0.90 ... 1.1) U <sub>N</sub>	
Energy-saving mode (-40...+85)°C		
Operating range for 1 s	(0.95...2.5) U <sub>N</sub>	
Holding voltage range DC	(0.32...0.65) U <sub>N</sub>	
Minimum holding power W	0.17	0.17
Must drop-out voltage DC	0.05 U <sub>N</sub>	

### Technical data

Mechanical life cycles	1 · 10 <sup>6</sup>	1 · 10 <sup>6</sup>
Electrical life at rated load AC7a cycles	30 · 10 <sup>3</sup>	30 · 10 <sup>3</sup>
Operate/release time ms	25/5	25/5
Ambient temperature range (energy-saving mode) °C	-40...+70 (-40...+85)	-40...+70 (-40...+85)
Environmental protection	RTII	RTII

Approvals (according to type)



**Features**

A

**Printed circuit mount - 5.2 mm contact gap  
50 A Power relay for photovoltaic inverters**

- 2 and 3 pole versions (NO double break contacts)
- Contact gap  $\geq 5.2$  mm (according to VDE 0126-1-1, EN 62109-1, EN 62109-2)
- Suitable for inverters with DC input up to 1,500 V and AC output up to 690 V, installations up to 4,000 m above sea level
- DC coils, with only 170 mW holding power
- Reinforced insulation between coil and contacts
- 1.5 mm gap between PCB and relay base
- Suitable for use at ambient temperatures up to 85 °C (with energy-saving coil energization) or 60 °C (with standard coil energization)
- Meets the EN 60335-1 requirements of resistance to heat and fire (GWIT 775 °C and GWFI 850 °C)

**NEW 67.22-4500**



- 2 NO
- Contact gap  $\geq 5.2$  mm
- PCB mount

**NEW 67.23-4500**



- 3 NO
- Contact gap  $\geq 5.2$  mm
- PCB mount

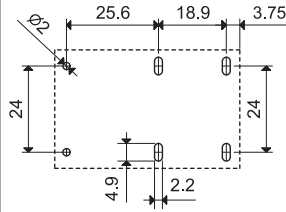
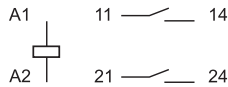

Copper side view

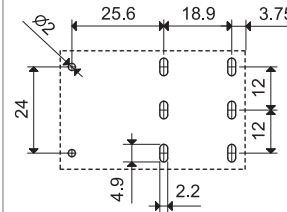
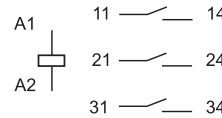

Copper side view

For outline drawing see page 6

<b>Contact specification</b>			
Contact configuration		2 NO (DPST-NO)	3 NO (3PST-NO)
Contact gap	mm	$\geq 5.2$	$\geq 5.2$
Rated current/Maximum peak current (for 5 ms)	A	50/150	50/150
Rated voltage/Maximum switching voltage	V AC	400/690	400/690
Rated load AC1/AC7a (per pole)	VA	20,000	20,000
Rated load AC15 (per pole @ 230 V AC)	VA	2,300	2,300
Single-phase motor rating (230 V AC)	kW	2	2
Three-phase motor rating (480 V AC)	kW	—	7
Breaking capacity DC1: 24/110/220	A	50/7/2	50/7/2
Minimum switching load	mW (V/mA)	1,000 (10/10)	1,000 (10/10)
Standard contact material		AgSnO <sub>2</sub>	AgSnO <sub>2</sub>
<b>Coil specification</b>			
Nominal voltage (U <sub>N</sub> )	V DC	5 - 6 - 8 - 12 - 24 - 48 - 60 - 110	
Rated power	W	2.7	2.7
Operating range (-40...+60°C)	DC	(0.90 ... 1.1) U <sub>N</sub>	(0.90 ... 1.1) U <sub>N</sub>
Energy-saving mode (-40...+85)°C	Operating range for 1 s	(0.95...2.5) U <sub>N</sub>	(0.95...2.5) U <sub>N</sub>
	Holding voltage range	(0.25...0.5) U <sub>N</sub>	(0.25...0.5) U <sub>N</sub>
	Minimum holding power	W	0.17
Must drop-out voltage	DC	0.05 U <sub>N</sub>	0.05 U <sub>N</sub>
<b>Technical data</b>			
Mechanical life	cycles	1 · 10 <sup>6</sup>	1 · 10 <sup>6</sup>
Electrical life at rated load AC7a	cycles	30 · 10 <sup>3</sup>	30 · 10 <sup>3</sup>
Operate/release time	ms	30/4	30/4
Ambient temperature range (energy-saving mode)	°C	-40...+60 (-40...+85)	-40...+60 (-40...+85)
Environmental protection		RTII	RTII
<b>Approvals</b> (according to type)			

## Ordering information

Example: 67 series solar relay, single PCB terminals, 2 pole NO,  $\geq 3$  mm contact gap .

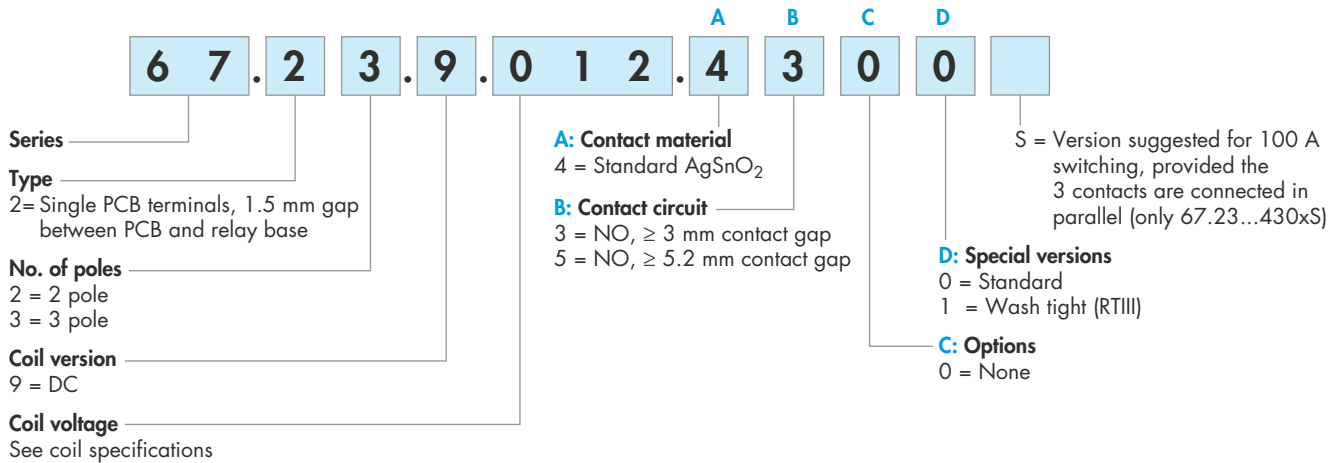

## Technical data

Insulation according to EN 61810-1				
Nominal voltage of supply system	V AC	400/690 3-phase	400 1-phase	230/400
Rated insulation voltage	V AC	630	400	400
Pollution degree		3		
Insulation between coil and contact set				
Type of Insulation		Reinforced		
Overvoltage category		III		
Rated impulse voltage	kV (1.2/50 $\mu$ s)	6		
Dielectric strength	V AC	4,000		
Insulation between adjacent contacts				
Type of Insulation		Basic		
Overvoltage category		III		
Rated impulse voltage	kV (1.2/50) $\mu$ s	6		
Dielectric strength	V AC	2,500		
Insulation between open contacts				
Type of disconnection		Micro-disconnection *	Full-disconnection	
Overvoltage category		—	III	
Rated impulse voltage	kV (1.2/50) $\mu$ s	—	4	
Dielectric strength	V AC	2,500 (67.xx-4300) / 3,000 (67.xx-4500)		
Conducted disturbance immunity				
Burst (5...50)ns, 5 kHz, on A1 - A2		EN 61000-4-4	level 4 (4 kV)	
Surge (1.2/50 $\mu$ s) on A1 - A2 (differential mode)		EN 61000-4-5	level 4 (4 kV)	
Other data				
Bounce time: NO	ms	2		
Vibration resistance (10...150)Hz: NO	g	15		
Shock resistance	g	35		
Power lost to the environment	without contact current	W	1.7 (67.xx-4300) / 2.7 (67.xx-4500)	
	with rated current	W	8.5 (67.xx-4300) / 9.5 (67.xx-4500)	
Recommended distance between relays mounted on PCB	mm	$\geq 20$		

\* with overvoltage category II: Full-disconnection

Contact specification

F 67 - Electrical life vs contact current (AC1/AC7a load)

A

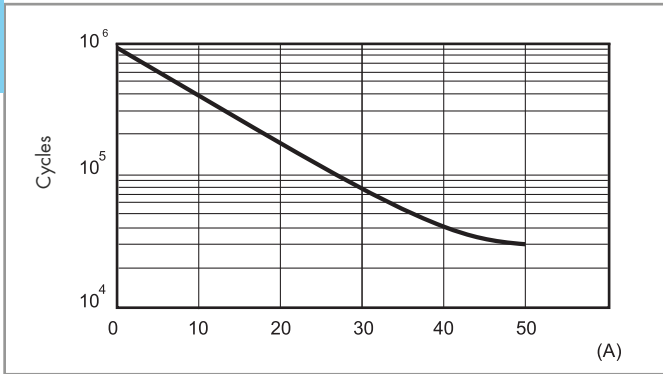

H 67 - Maximum DC breaking capacity (67.xx-4300)

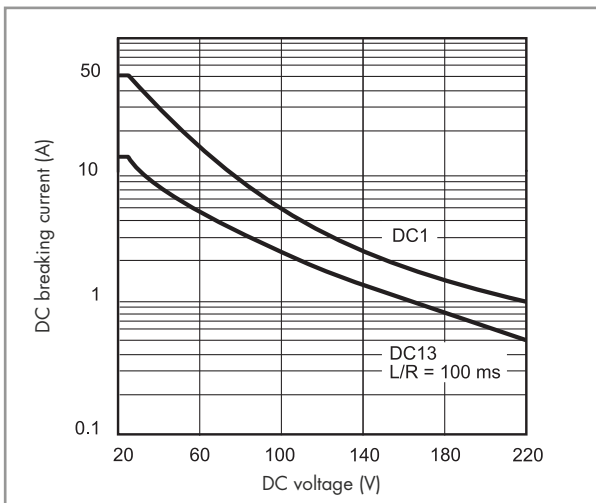

When switching a resistive (DC1) or inductive (DC13) load having voltage and current values under the corresponding curve, an electrical life of > 30 000 cycles can be expected.

H 67 - Maximum DC breaking capacity (67.xx-4500)

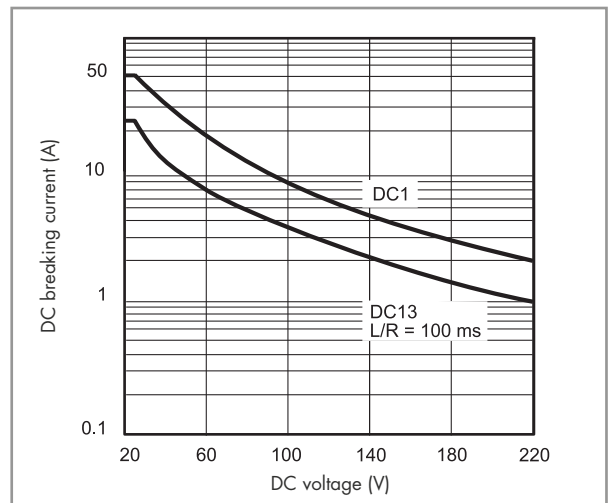

When switching a resistive (DC1) or inductive (DC13) load having voltage and current values under the corresponding curve, an electrical life of > 30 000 cycles can be expected.

## Coil specifications

### DC coil data, 67.xx-4300

Nominal voltage $U_N$ V	Coil code	Operating range (@ 70 °C max)		Holding voltage $U_h$ V	Resistance R $\Omega$	Rated coil consumption I at $U_N$ $I_N$ mA
		$U_{min}$ V	$U_{max}$ V			
5	9.005	4.5	5.5	1.6	14.7	340
6	9.006	5.4	6.6	1.9	21.5	279
8	9.008	7.2	8.8	2.6	37.6	213
12	9.012	10.8	13.2	3.8	85	141
24	9.024	21.6	26.4	7.7	340	71
48	9.048	43.2	52.8	15.4	1,355	35
60	9.060	54	66	19.2	2,120	28
110	9.110	99	121	35.2	7,120	15

### DC coil data, 67.xx-4500

Nominal voltage $U_N$ V	Coil code	Operating range (@ 60 °C max)		Holding voltage $U_h$ V	Resistance R $\Omega$	Rated coil consumption I at $U_N$ $I_N$ mA
		$U_{min}$ V	$U_{max}$ V			
5	9.005	4.5	5.5	1.25	9.3	538
6	9.006	5.4	6.6	1.5	13.5	444
8	9.008	7.2	8.8	2	23.7	338
12	9.012	10.8	13.2	3	53.5	224
24	9.024	21.6	26.4	6	213	113
48	9.048	43.2	52.8	12	855	56
60	9.060	54	66	15	1,335	45
110	9.110	99	121	27.5	4,500	24

**R 67 - Operating range v ambient temperature, 67.xx-4300**  
with standard (continuous) coil energization (-40...+70)°C

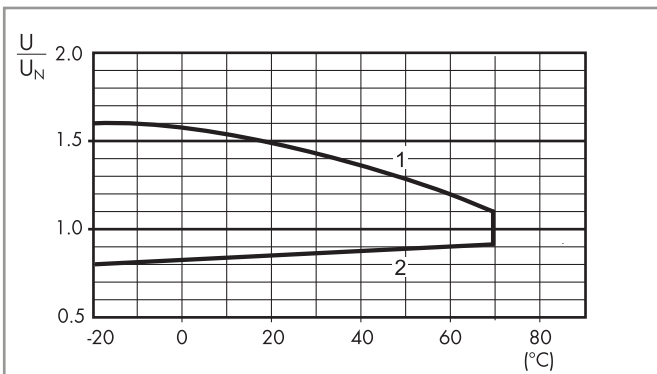

1 - Max. permitted coil voltage.  
2 - Min. pick-up voltage with coil at ambient temperature.

**R 67 - Operating range v ambient temperature, 67.xx-4500**  
with standard (continuous) coil energization (-40...+60)°C

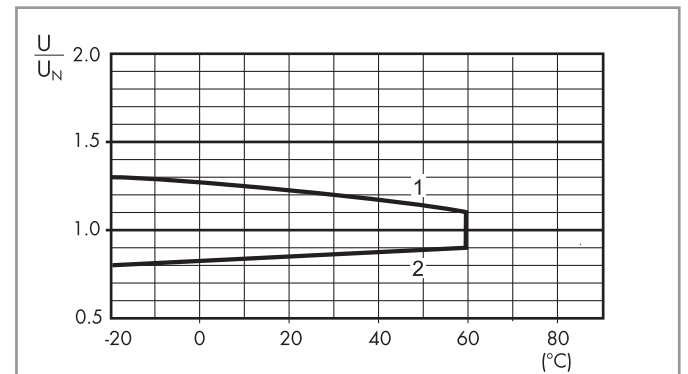

1 - Max. permitted coil voltage.  
2 - Min. pick-up voltage with coil at ambient temperature.

### Energy saving mode

In some applications, such as photovoltaic inverters, it may be necessary to minimize the overall relay power dissipation and to permit use at higher ambient temperature levels (up to 85 °C). This can be achieved by initially applying a coil voltage within the Energy saving mode Operating range (see diagram to the right) and then rapidly (< 1 s) reducing the coil voltage to a level within the Holding voltage range. The lower the Holding voltage, the lower is the continuous power dissipation of the coil (0.17 W minimum). Coil voltages as high as  $2.5U_N$  may be used, when necessary, to reduce the contact operate time.

**R 67 - Operating range v ambient temperature, 67.xx-4300/4500**  
in energy saving mode (-40...+85)°C

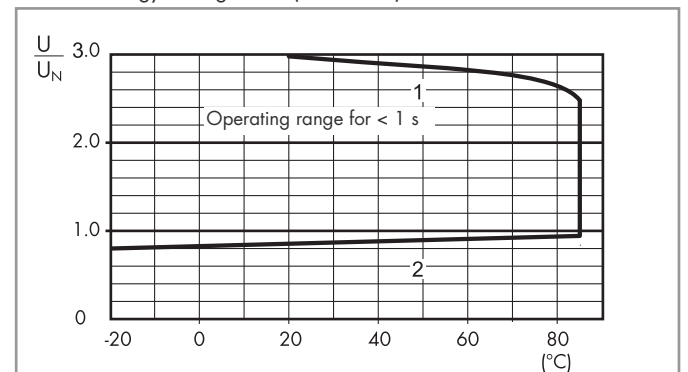

1 - Max. permitted coil voltage.  
2 - Min. pick-up voltage with coil at ambient temperature.

Outline drawings

A

Type 67.22

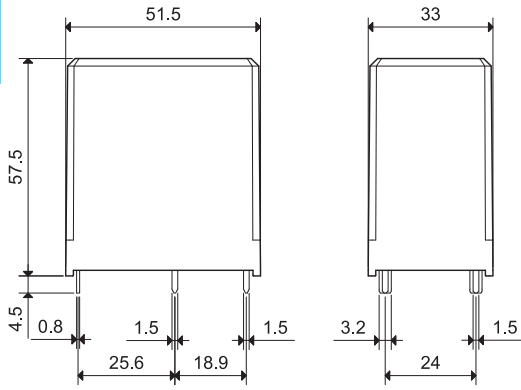

Type 67.23

